

Tomography of collagen fiber orientation in human tissue using depth-resolved second-harmonic-generation polarimetry

T. Yasui, Y. Hori, K. Sasaki, Y. Tohno*, and T. Araki

Grad. Sch. of Engg. Sci., Osaka Univ.

*Dept. of 1st Anat., Nara Medical Univ.

OWLS8 @ MELBOURNE

Introduction

Collagen orientation

Mechanical and functional property of tissue and organ

Non-invasive, non-destructive
non-contact, non-staining

△ Conventional optical probe
(scattering, absorption, fluorescence)

Collagen molecule induced

Second-Harmonic-Generation (SHG) light





- Nonlinear interaction with ultrashort pulse light
- Specifically generated from collagen molecule in tissue components
- Sensitive to collagen orientation

➔ **SHG polarimetry**

ref) T. Yasui et al, *J. Biomed. Opt.* Vol. 9, pp.259-264 (2004).

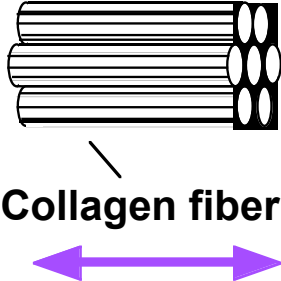
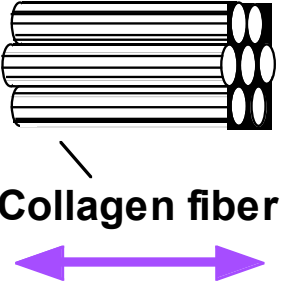
T. Yasui et al, *Appl. Opt.*, Vol. 43, pp. 2861-2867 (2004).

Orientation vs. Polarization

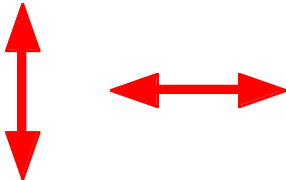
	Axial (Non-centrosymmetric)		Cross-sectional (Centrosymmetric)
	Parallel	Perpendicular	
Collagen orientation	 Collagen fiber	 Collagen fiber	 Collagen fiber
Laser polarization			
SHG light	Strong	Weak	None

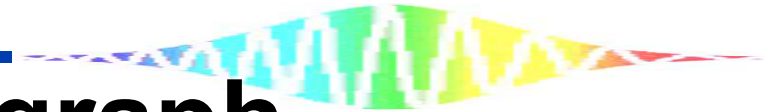

← Expected orientation

SHG radar graph

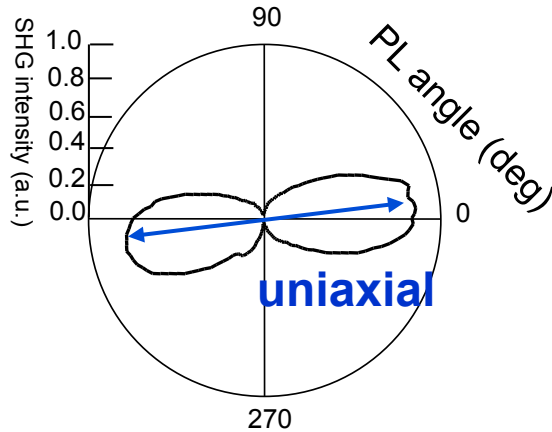

Human Achilles tendon

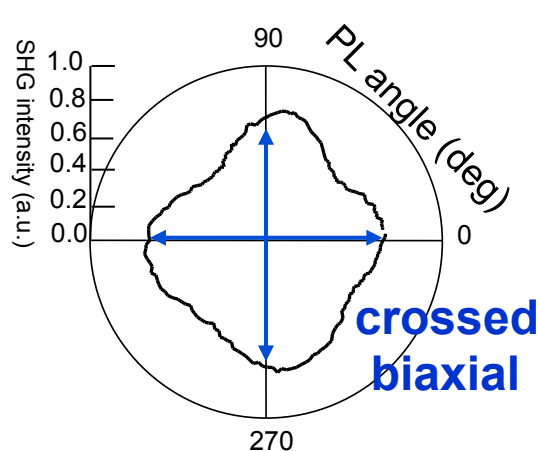

Human dentin

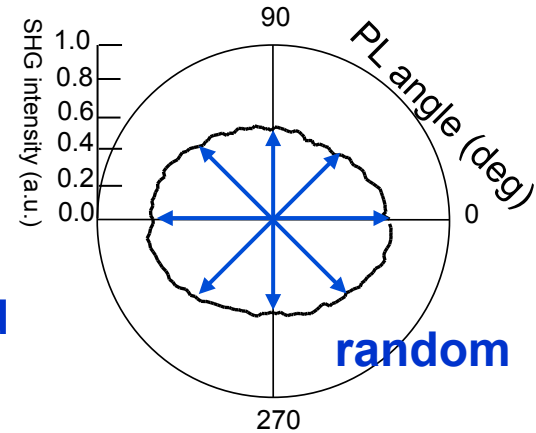

Collagen sponge

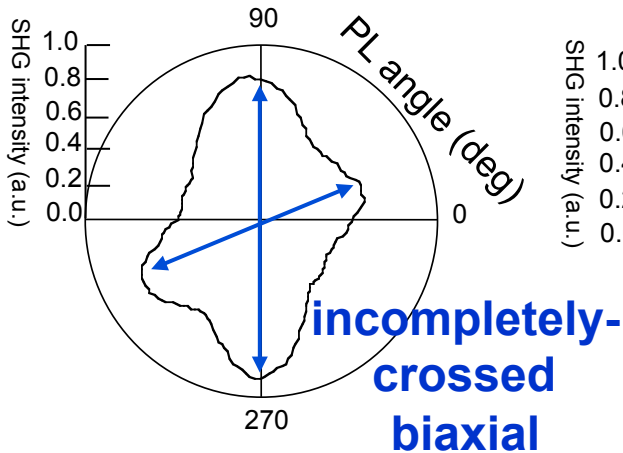

Human anklebone

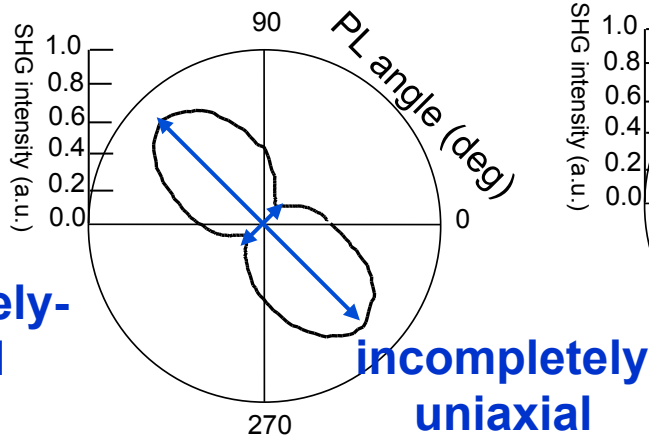

Human reticular dermis

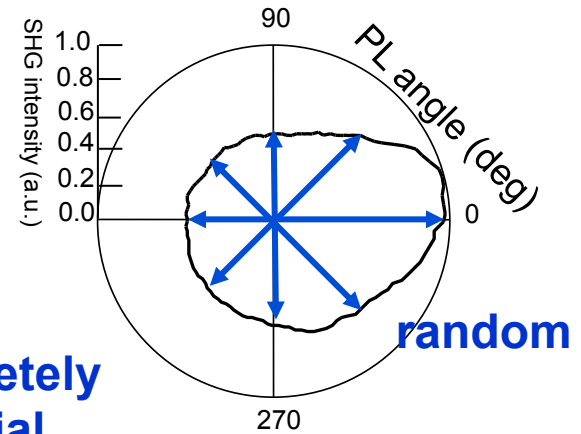

**Human papillary dermis
(across epidermis layer)**

Tissue dependence of collagen orientation

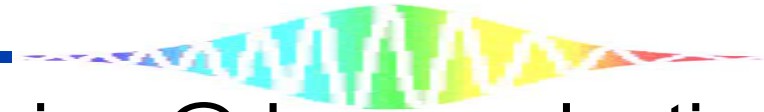

Polarization-resolved SHG imaging @ human dentin

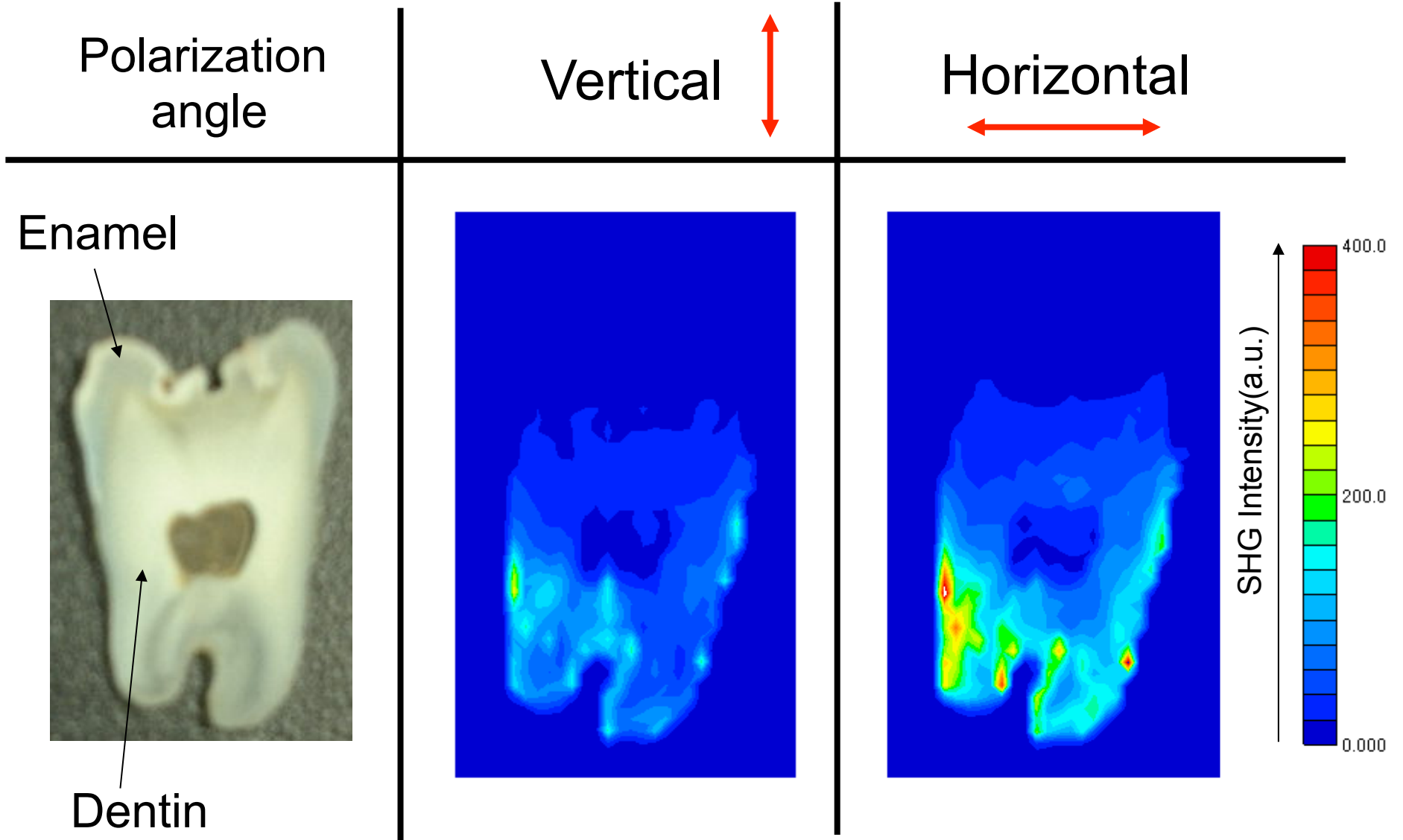

Localization of SHG light

Polarization-resolved SHG imaging @ human Achilles tendon

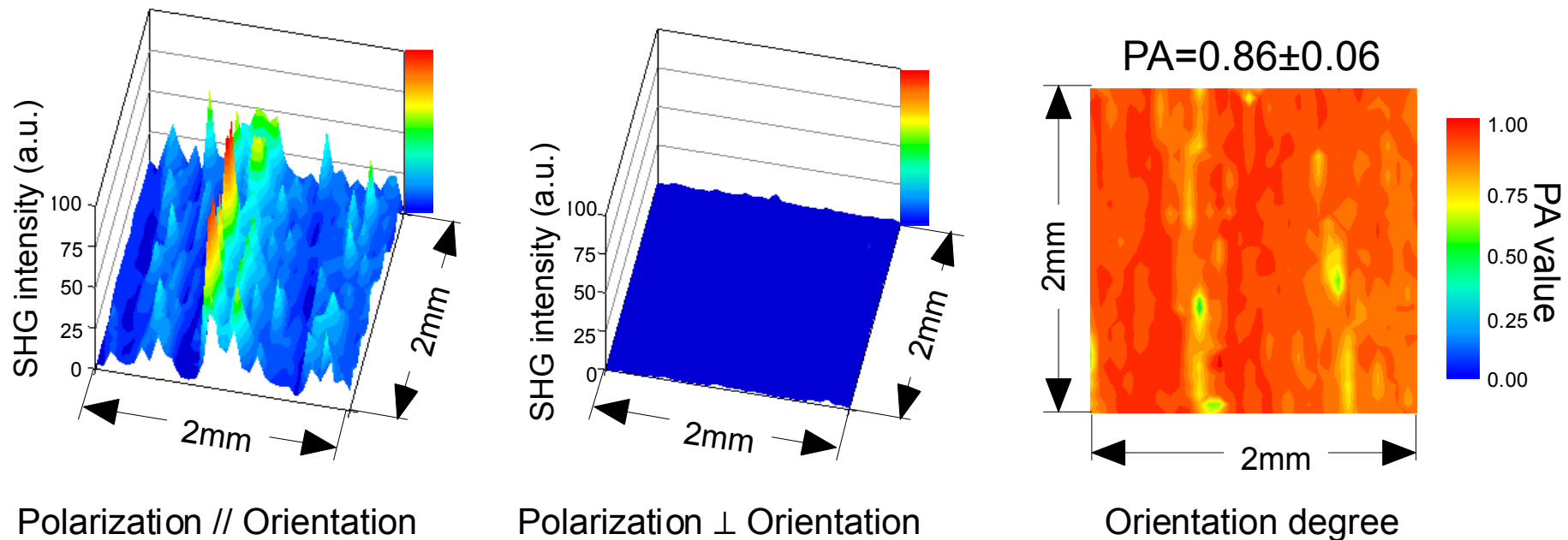

Uniform distribution of high PA values



Collagen orientation arranged with high organization

Polarization-resolved SHG imaging @ collagen sponge

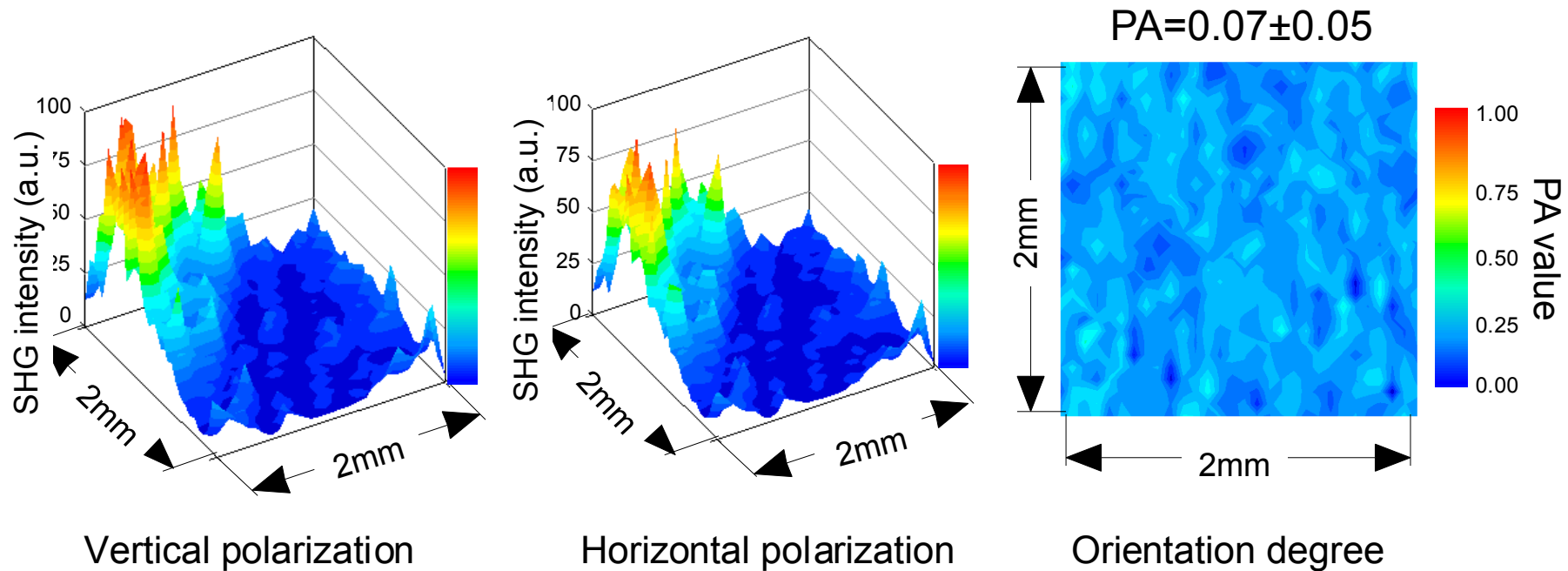

Uniform distribution of low PA values



Collagen orientation distributed equally in all directions

@J@Polarization-resolved SHG imaging @ human talus

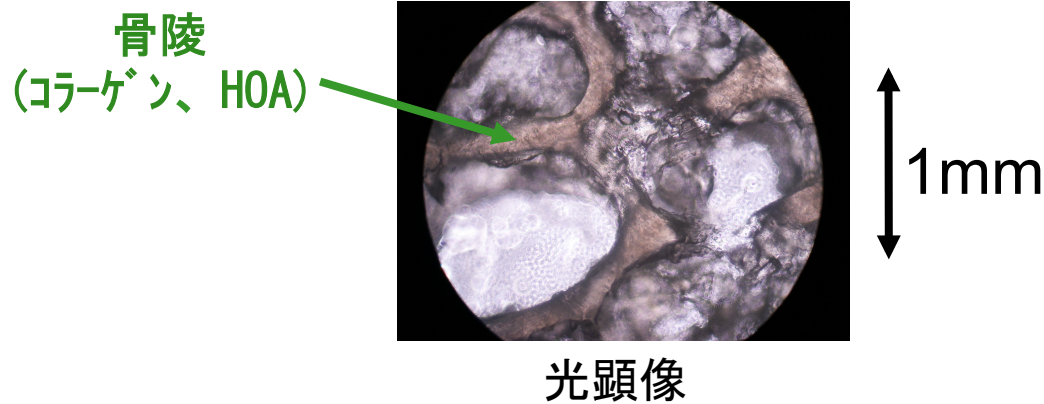
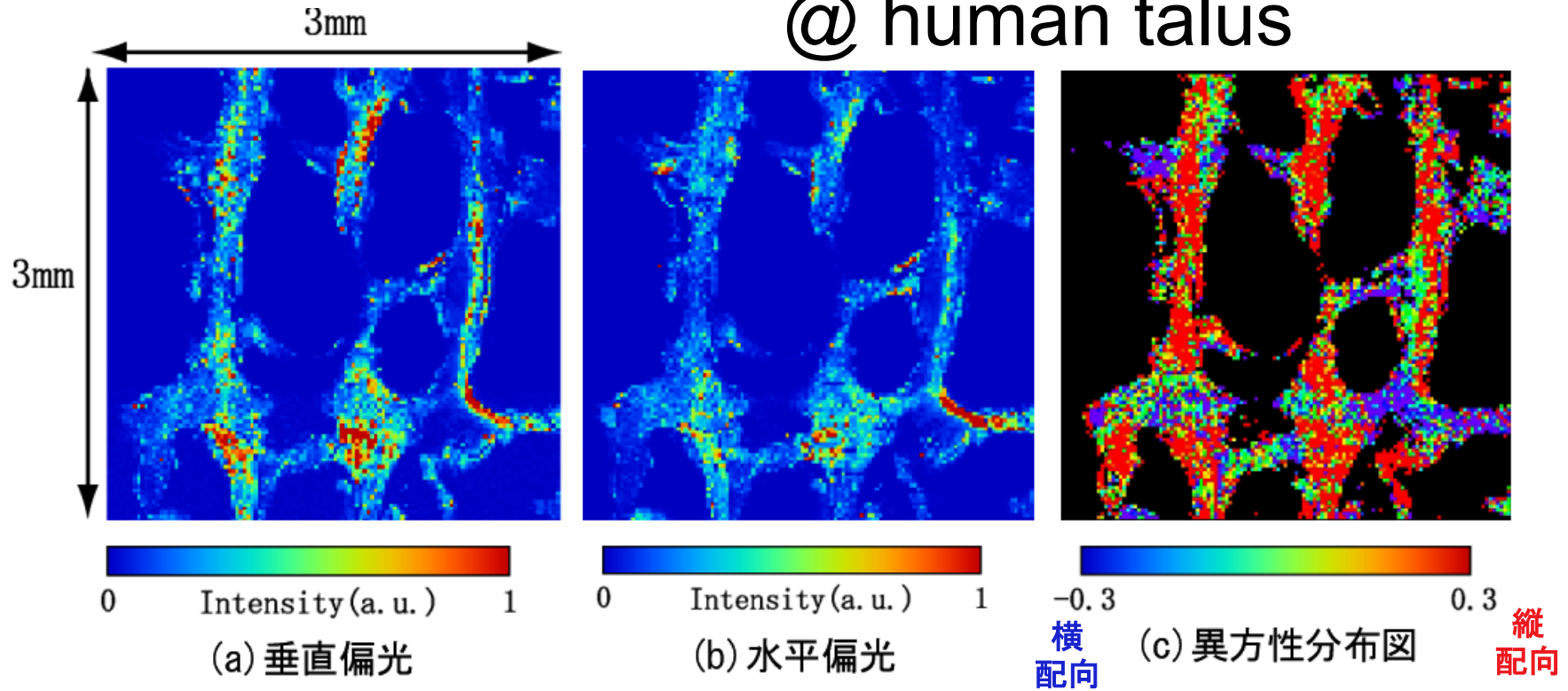

骨陵に沿った
コラーゲン配向

Microscopic 2D distribution of collagen orientation angle @reticular dermis

2D mapping of orientation angle

Polarization-resolved SHG image

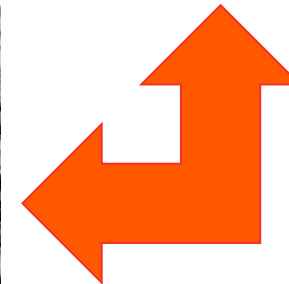
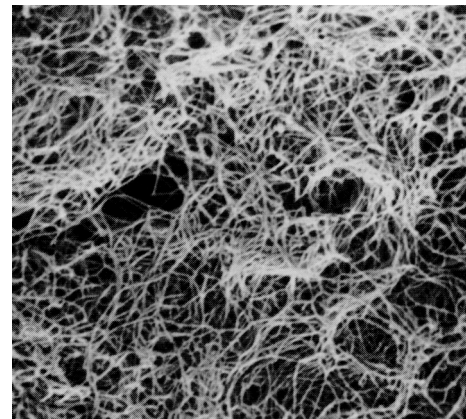
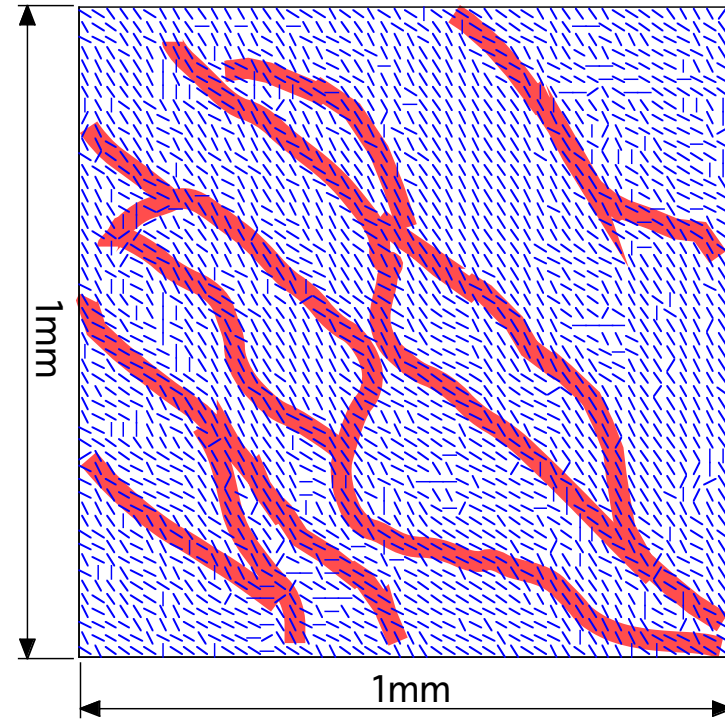
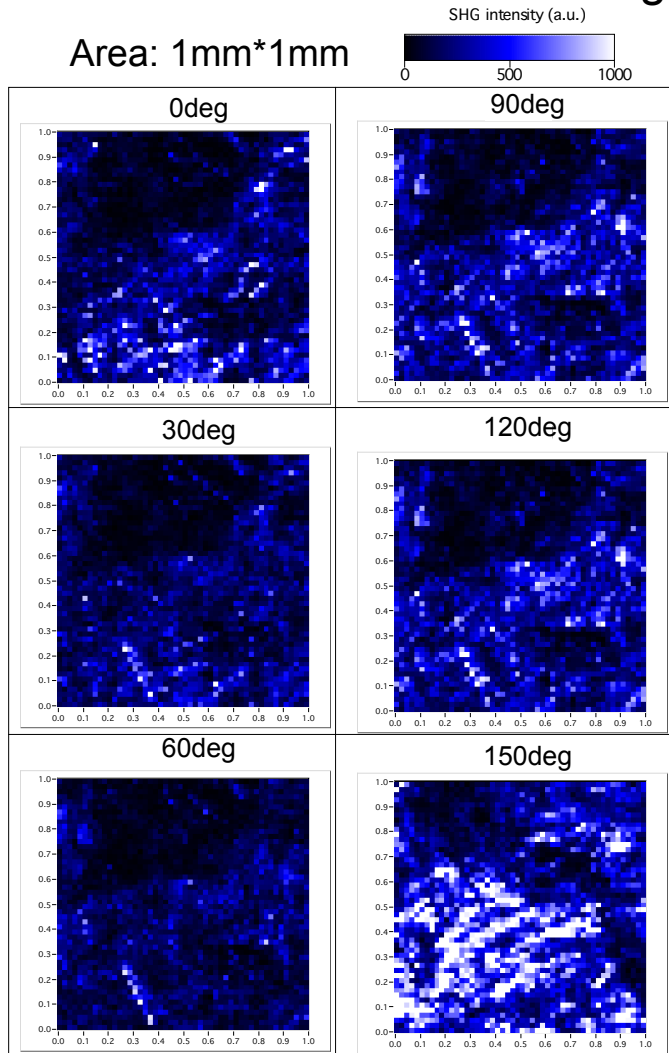

Entangled structure of collagen fiber

Microphotograph of bovine dermis

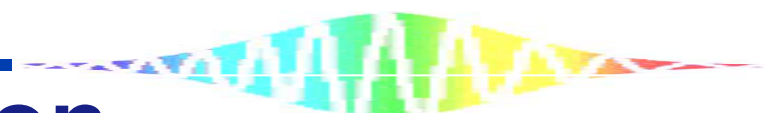

Introduction

Collagen orientation



Mechanical and functional property of tissue and organ

Non-invasive, non-destructive
non-contact, non-staining



△ Conventional optical probe
(scattering, absorption, fluorescence)

Collagen molecule induced

Second-Harmonic-Generation (SHG) light

- ➔ **SHG polarimetry**
- ➔ **Polarization-resolved SHG imaging**



Present talk

**Tomography of collagen fiber orientation in human tissues
based on depth-resolved SHG polarimetry**

Experimental setup

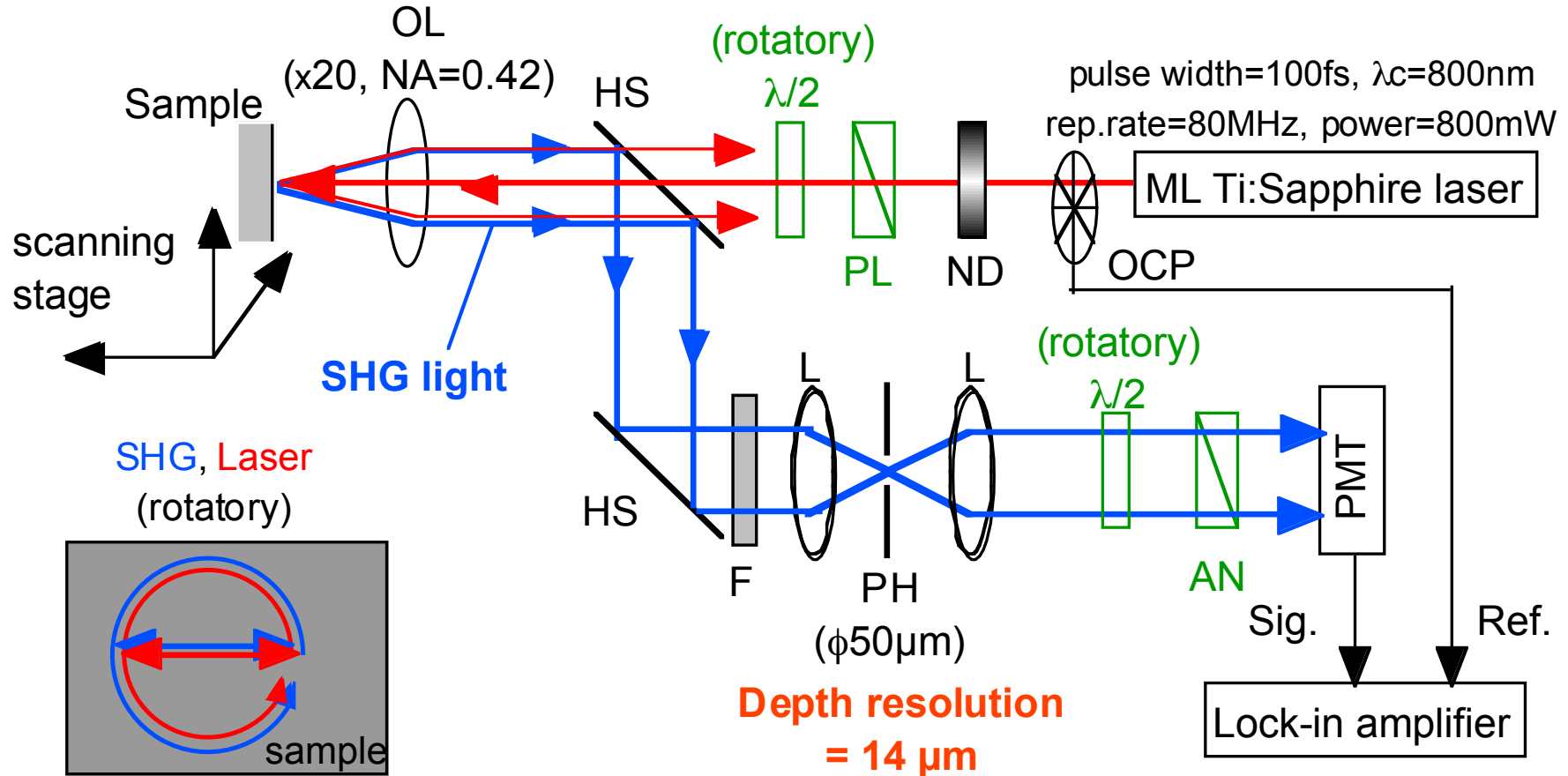

Polarization condition

OCP; optical chopper, ND; neutral density filter, P; polarizer, $\lambda/2$; half waveplate, HS; harmonic separator, OL; objective lens, PH; pinhole, F; blue pass filter, A; analyzer, PMT; photomultiplier

Human tissue sample

Soft tissue

Back dermis

- formalin fixation, washing and drying
- reticular layer
- 1mm thickness

Achilles tendon

- formalin fixation, washing and drying
- sliced along axial direction
- 2mm thickness

Hard tissue

Dentin

- sliced along tooth axis
- 1mm thickness

Anklebone

- sliced across section
- 1mm thickness

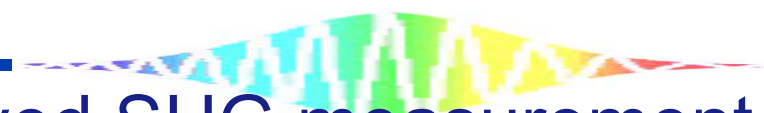

Penetration power of depth-resolved SHG measurement

Incident laser power = 20 mW

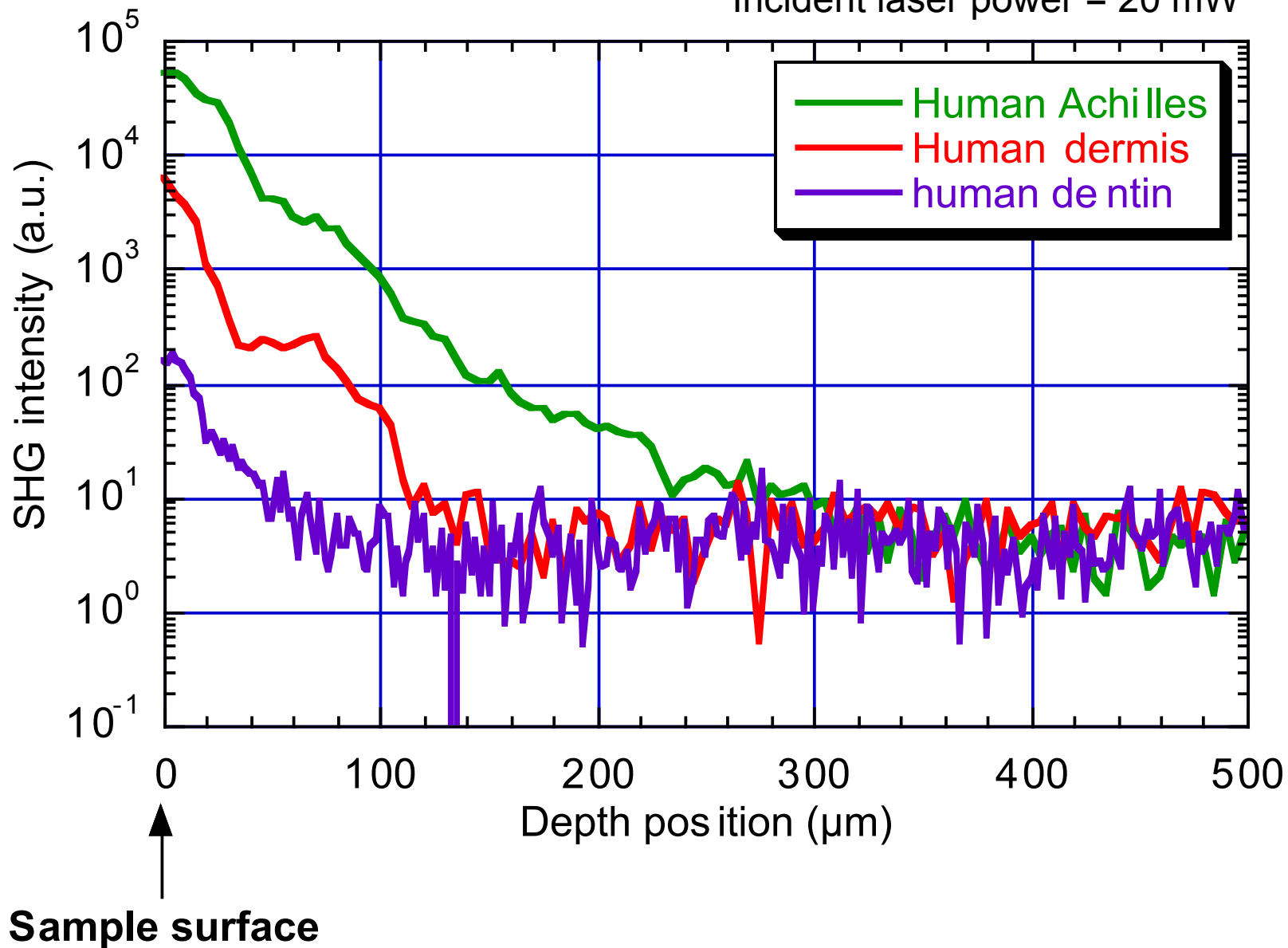

Basic performance of depth-resolved SHG polarimetry

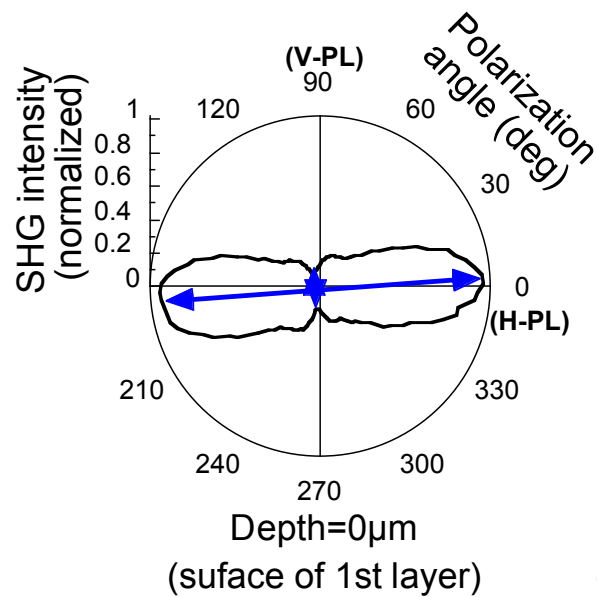
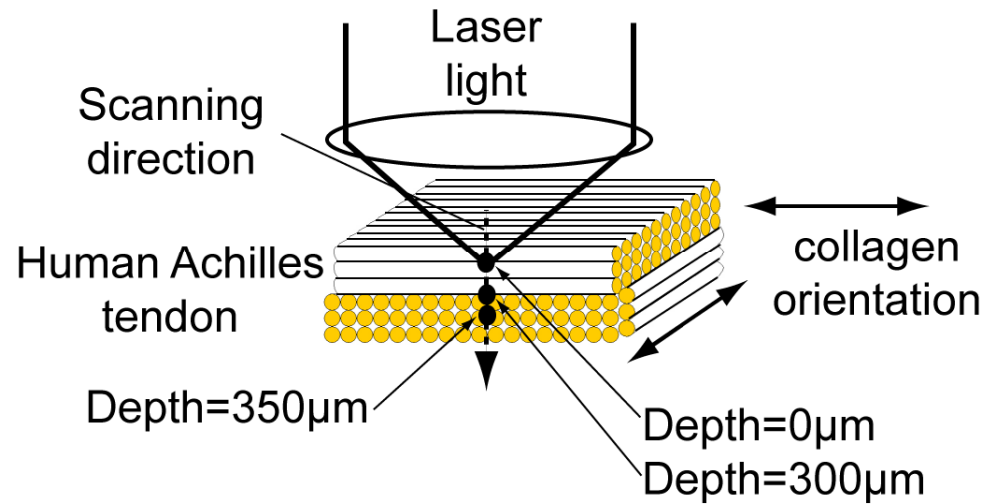

Horizontal Uniaxial

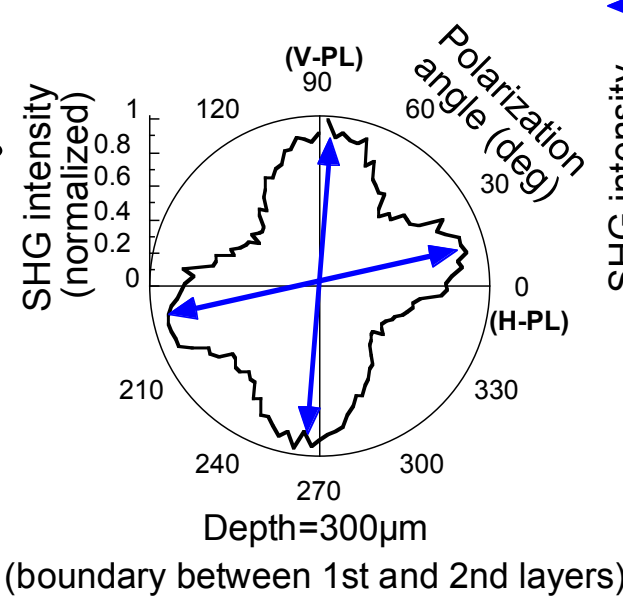

Mixture of horizontal and vertical

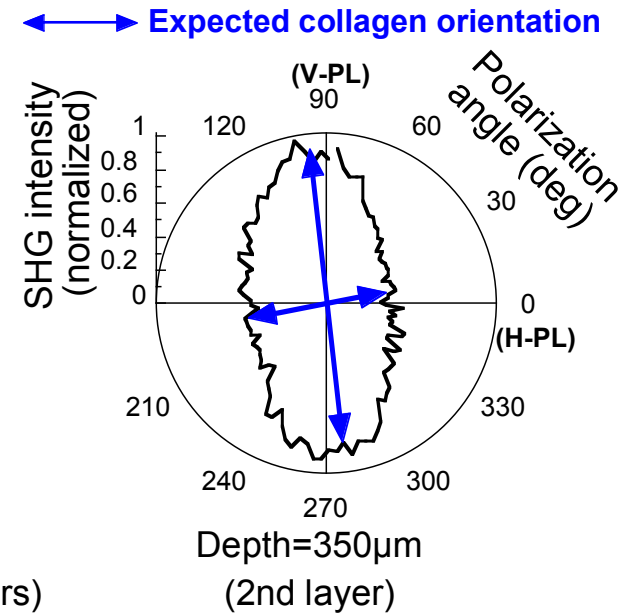

Vertical

Basic performance of depth-resolved SHG polarimetry

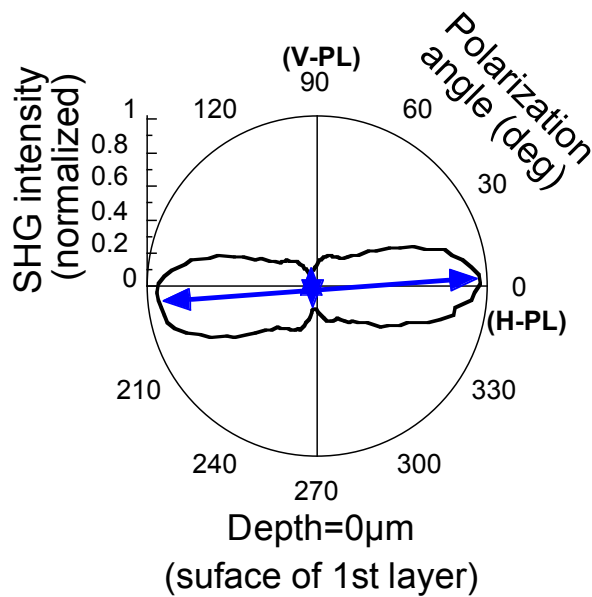
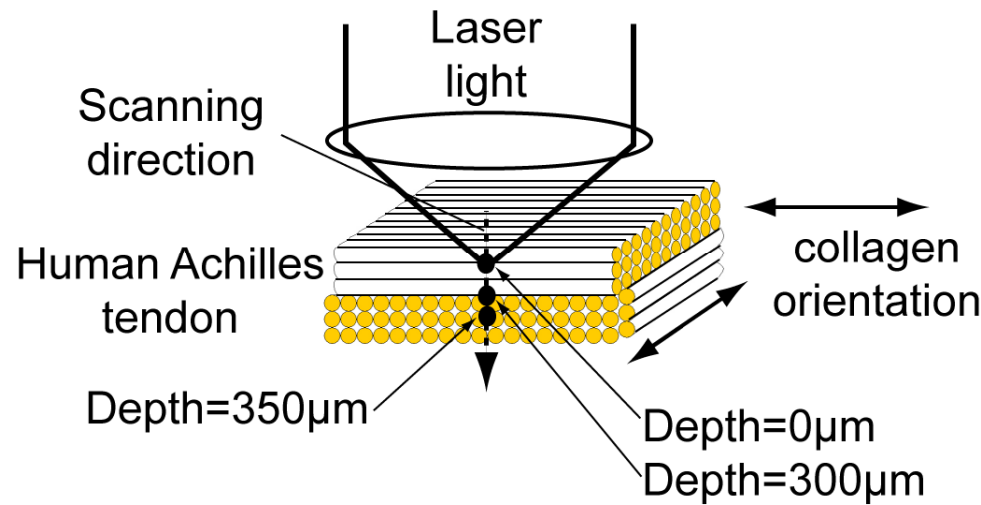

Horizontal Uniaxial

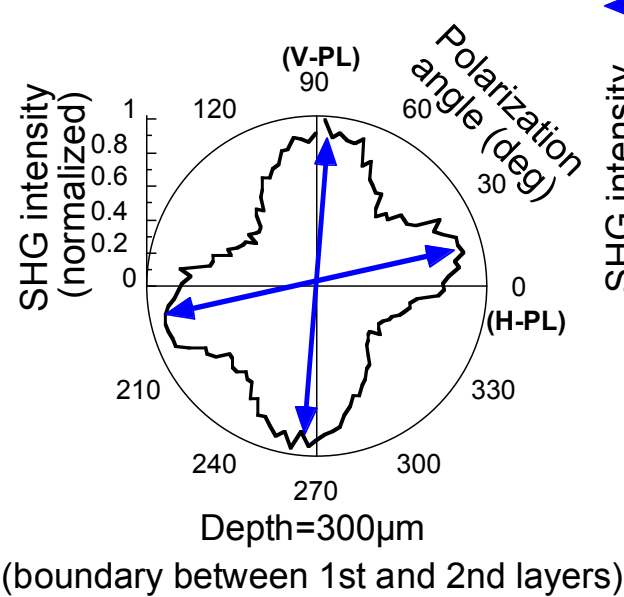

Mixture of horizontal and vertical

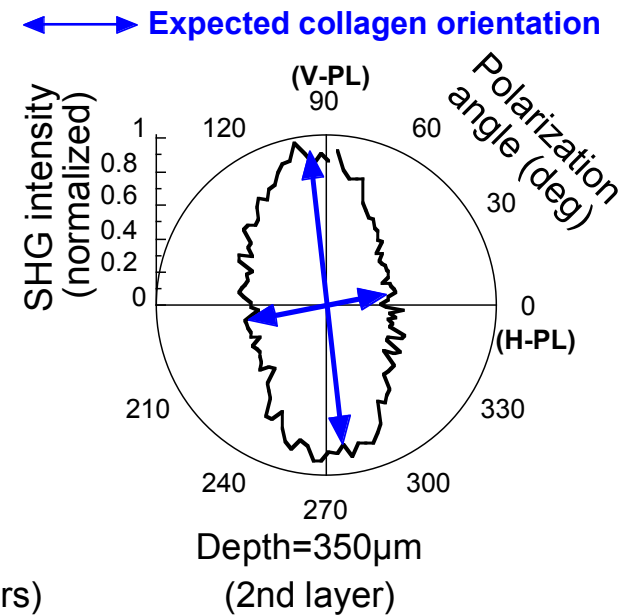

Vertical

Depth-resolved SHG radar graph of human tissue

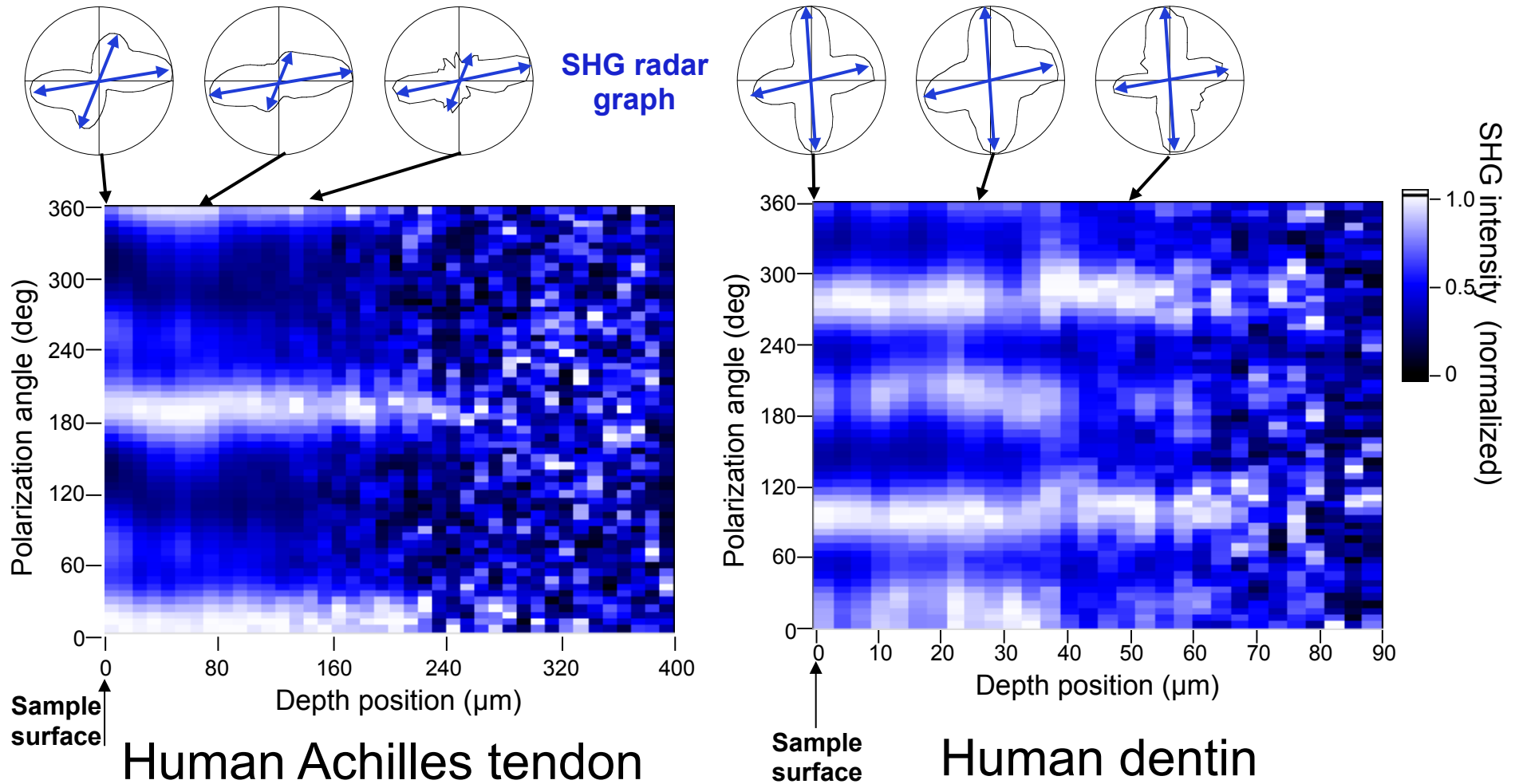

Uniform distribution of collagen orientation along depth direction

Depth-resolved imaging of 2D lateral distribution of collagen orientation in human anklebone

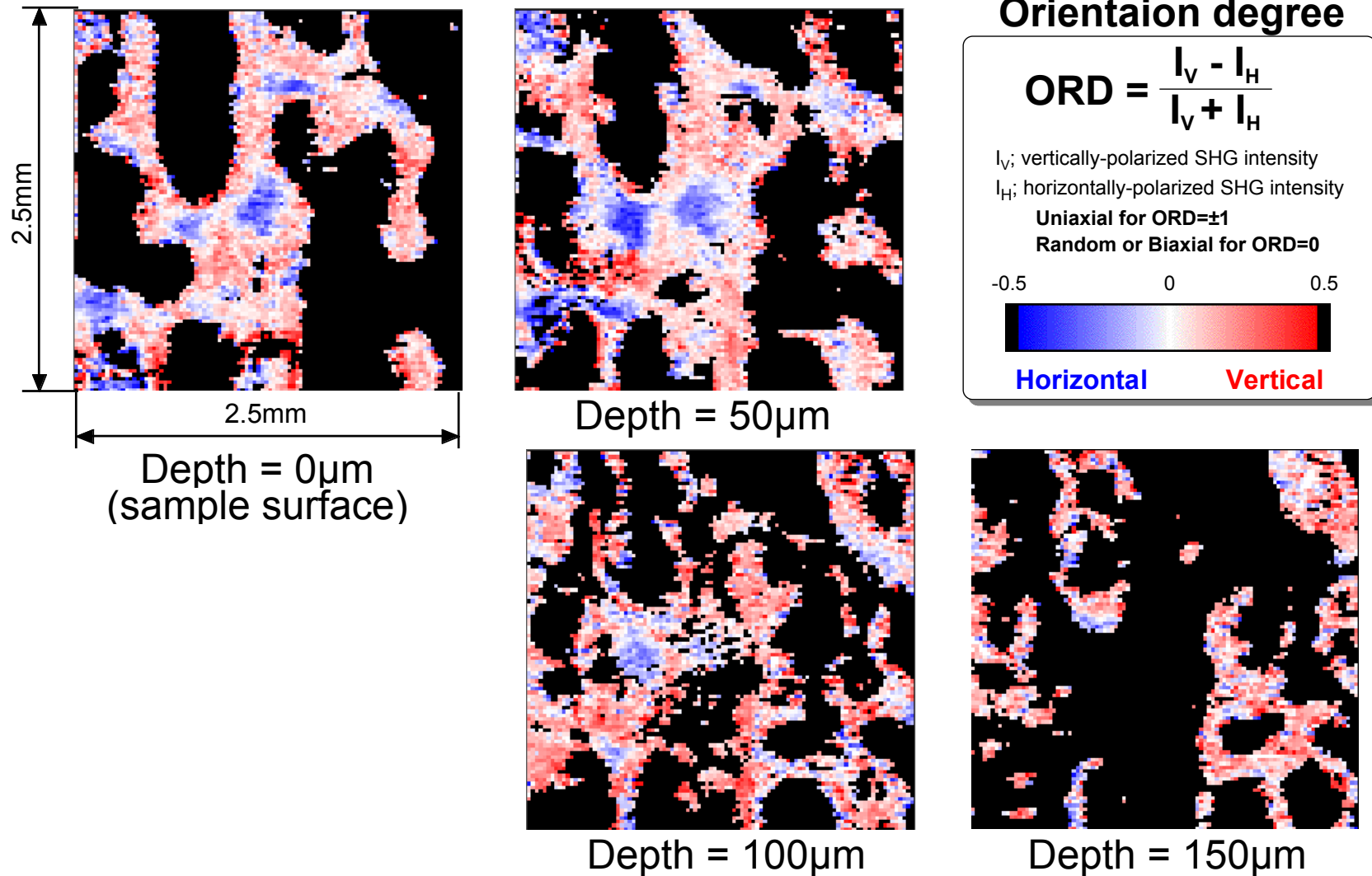

Collagen orientation parallel to bone crest direction developing along depth direction

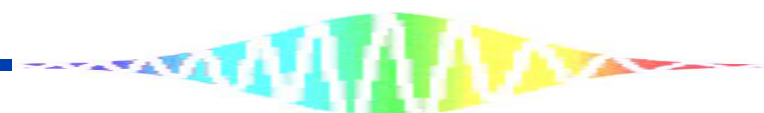

In vivo measurement of human skin

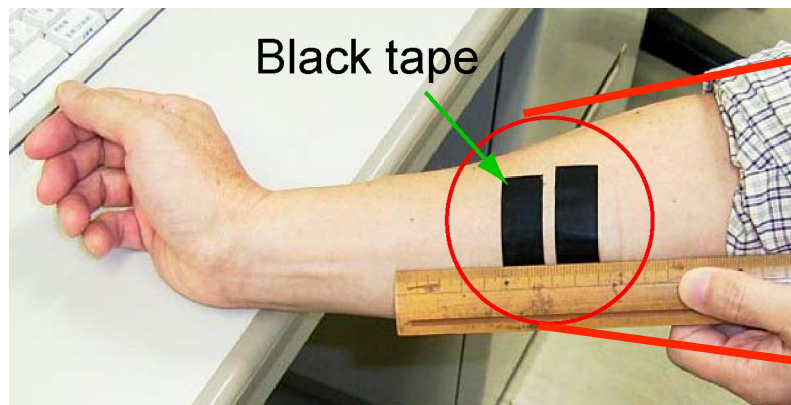

Volunteer's forehead

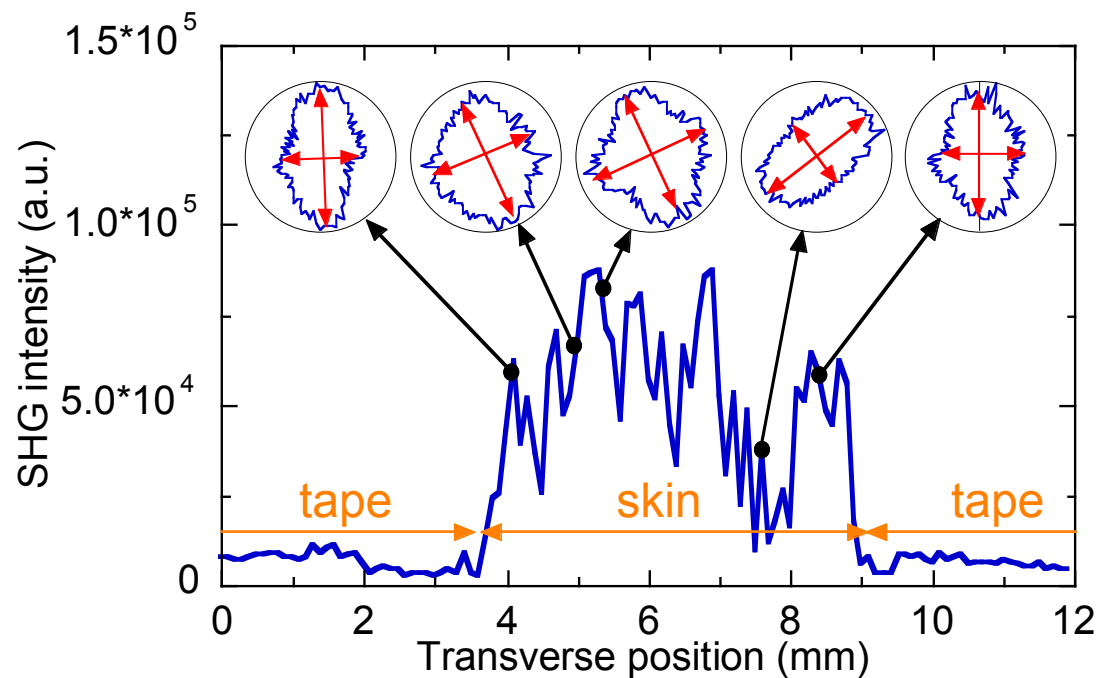
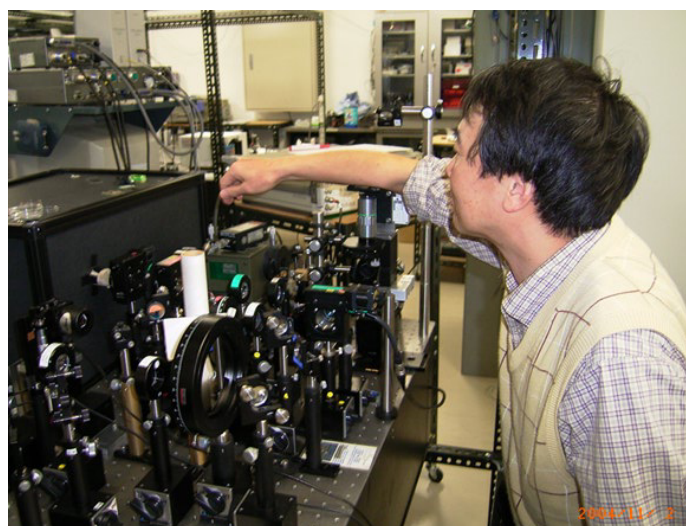
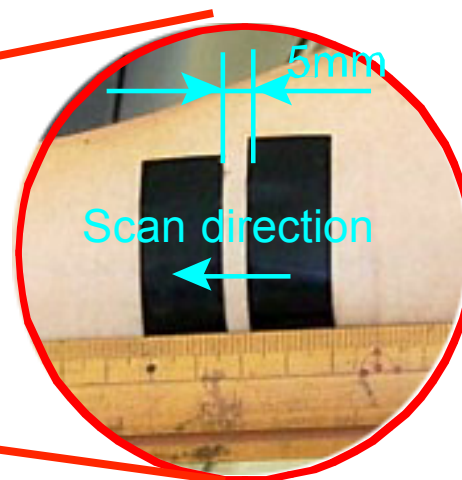

Summary

(1) Depth-resolved SHG polarimetry

- Depth resolution = 14 μm
- Penetration power = 100 μm @human hard tissue
150~300 μm @human soft tissue

(2) Tomography of collagen orientation in human tissue

- Depth-resolved SHG radar graph
- Depth-resolved imaging of 2D lateral distribution of collagen orientation

(3) *In vivo* measurement of human skin